

## DIMENSIONS

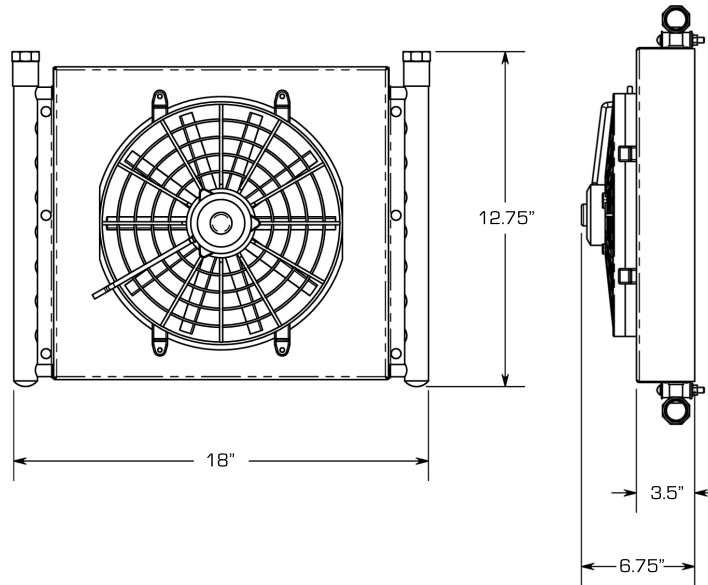

## APPEARANCE

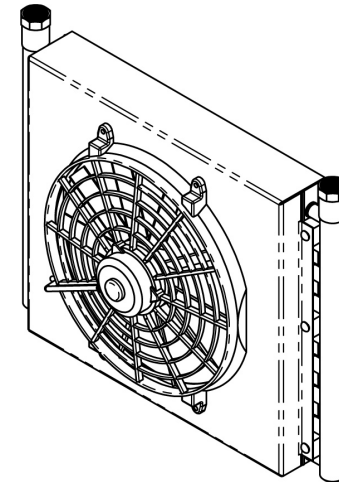

## SPECIFICATIONS

Flow Range (GPM): .....4 - 20  
Heat Rejection Range (BTU/Hr):  
15,100 - 19,700  
Fitting Size:.....3/4" FPT

### Material

Copper Tube:.....CDA122  
Inner Tube: .....Al-3003  
Inner Fin: .....Al - 1100  
Outer Fin: .....Al - 1100  
Fitting:.....Copper

### Cooler Weight (lbs.)

Total Weight :.....20 lbs.

## PERFORMANCE

