

DIMENSIONS

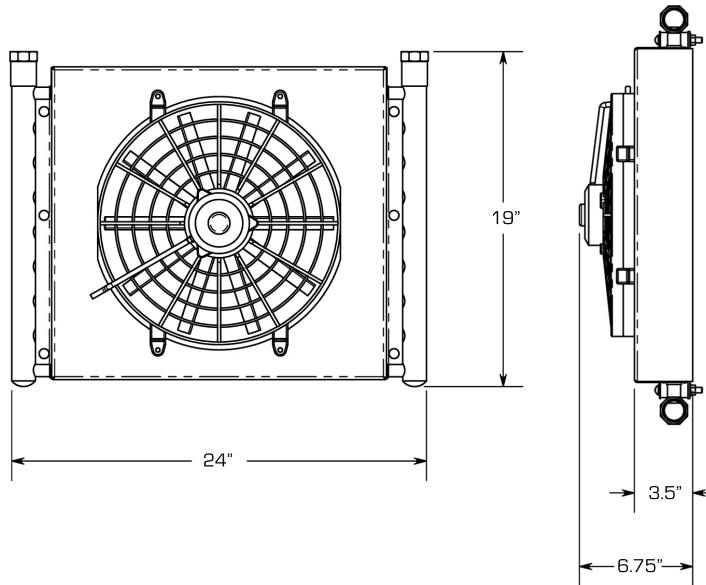

APPEARANCE

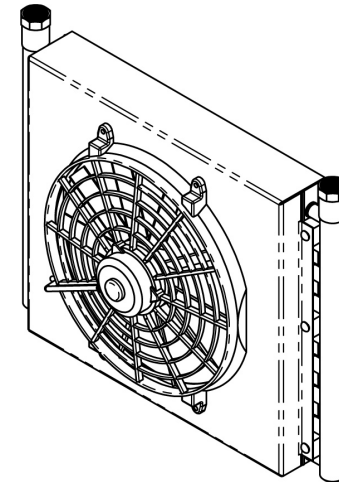

SPECIFICATIONS

Flow Range (GPM):5 - 21
Heat Rejection Range (BTU/Hr):
22,900 - 31,100
Fitting Size:.....3/4" FPT

Material

Copper Tube:.....CDA122
Inner Tube:Al-3003
Inner Fin:Al - 1100
Outer Fin:Al - 1100
Fitting:.....Copper

Cooler Weight (lbs.)

Total Weight :.....24 lbs.

PERFORMANCE

