

DIMENSIONS

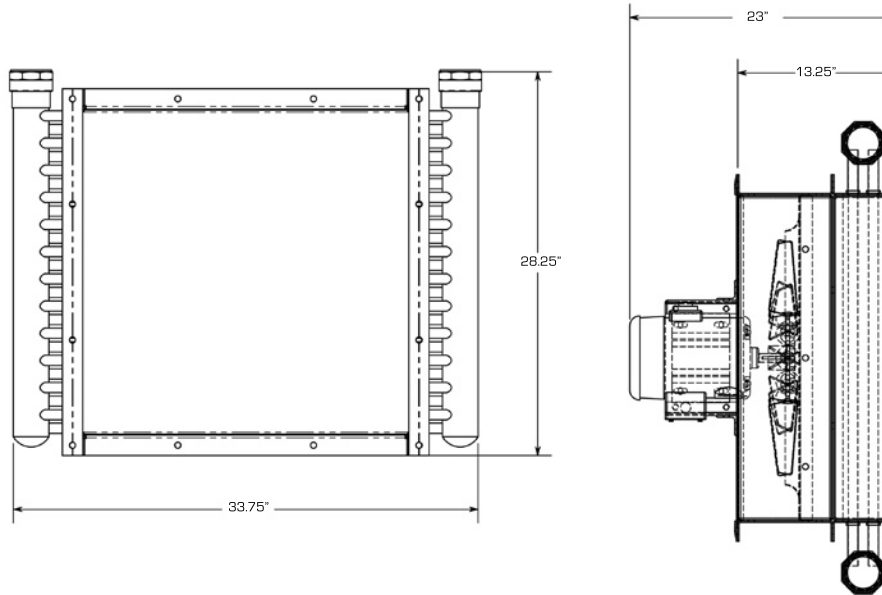

APPEARANCE

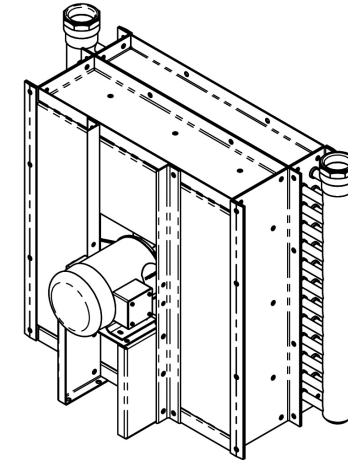

SPECIFICATIONS

Flow Range (GPM):20 - 140
 Heat Rejection Range (BTU/Hr):
 134,400 - 212,400
 Fitting Size:.....2-1/2" FPT
Material
 Copper Tube:.....CDA122
 Inner Tube:.....Al-3003
 Inner Fin:Al - 1100
 Outer Fin:Al - 1100
 Fitting:.....Copper
Cooler Weight (lbs.)
 Total Weight :.....151
 (electrical) lbs.

PERFORMANCE

PART NO. (COMPLETE)	ELECTRIC MOTOR SPEC. VOLTS/PHASE/HERTZ	HYDRAULIC MOTOR SPEC. GPM@ PSI	ELECTRIC MOTOR REQD. FRAME/HP/RPM
DB-312-B	w / o motor/ fan, air plenum	N/A	56 / 3/4 / 1725
DB-312-0	w / o motor	N/A	56 / 3/4 / 1725
DB-312-1	115-230 / 1 / 60	N/A	56 / 3/4 / 1725
DB-312-2	230-460 / 3 / 60	N/A	56 / 3/4 / 1725
DB-312-3	N/A	1.5 @ 1500	
DB-312-4	N/A	2.0 @ 1000	
DB-312-5	N/A	2.5 @ 700	
DB-312-6	N/A	3.0 @ 600	
DB-312-7	N/A	3.5 @ 500	

