

DIMENSIONS

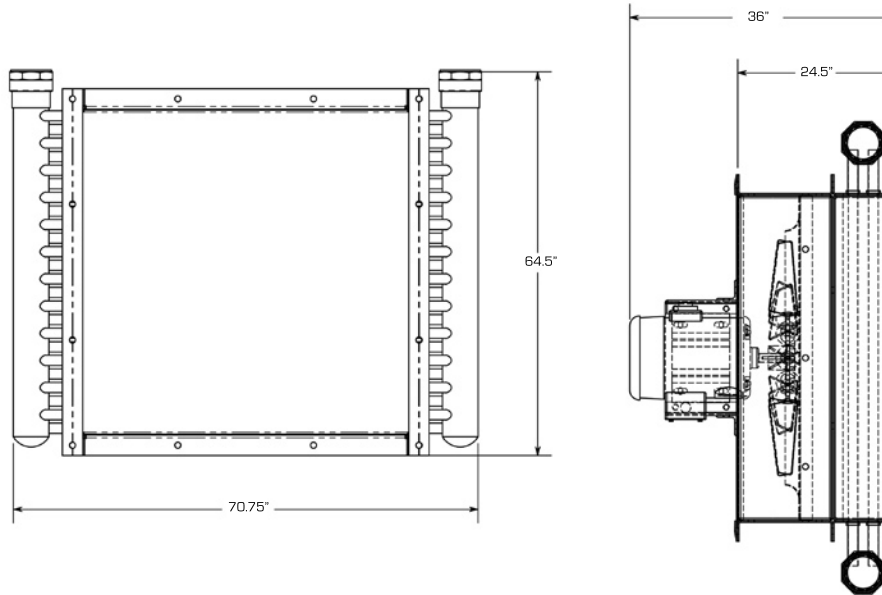

APPEARANCE

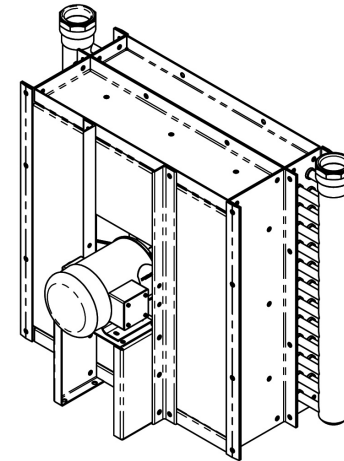

SPECIFICATIONS

Flow Range (GPM):40 - 190
 Heat Rejection Range (BTU/Hr):
 610,600 - 1,042,500
 Fitting Size:.....3ASA*
 (ASA round flange, 150 pound)

Material

Copper Tube:.....CDA122
 Inner Tube:Al-3003
 Inner Fin:Al - 1100
 Outer Fin:Al - 1100
 Fitting:.....Copper

Cooler Weight (lbs.)

Total Weight :.....956
 (electrical) lbs.

PERFORMANCE

PART NO. (COMPLETE)	ELECTRIC MOTOR SPEC. VOLTS/PHASE/HERTZ	HYDRAULIC MOTOR SPEC. GPM@ PSI	ELECTRIC MOTOR REQD. FRAME/HP/RPM
DB-330-B	w / o motor/ fan, air plenum	N/A	254T / 7.5 / 1140
DB-330-0	w / o motor	N/A	254T / 7.5 / 1140
DB-330-1	230-460 / 3 / 60	N/A	254T / 7.5 / 1140
DB-330-2	N/A	9.0 @ 1800	
DB-330-3	N/A	11.5 @ 1500	

